

Data Sheet



Article number: 20957425

Description: E+G Levelling foot
GN 343.3-25-M6-A

Measures

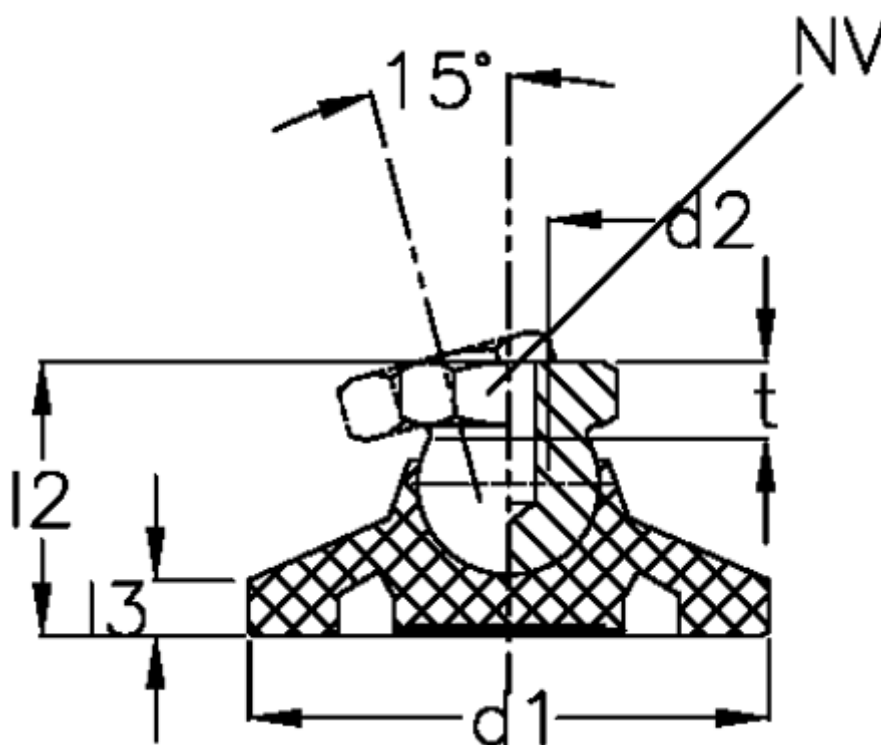

d_1	= 25
d_2	= M 6
l_2	= 18.5
l_3	= 4.0
NV	= 12.0
Static load (N)	= 5000
t min	= 9.0